



SWITCH

The Swiss Education & Research Network

AAI Attributes

Thomas Lenggenhager, <lenggenhager@switch.ch>

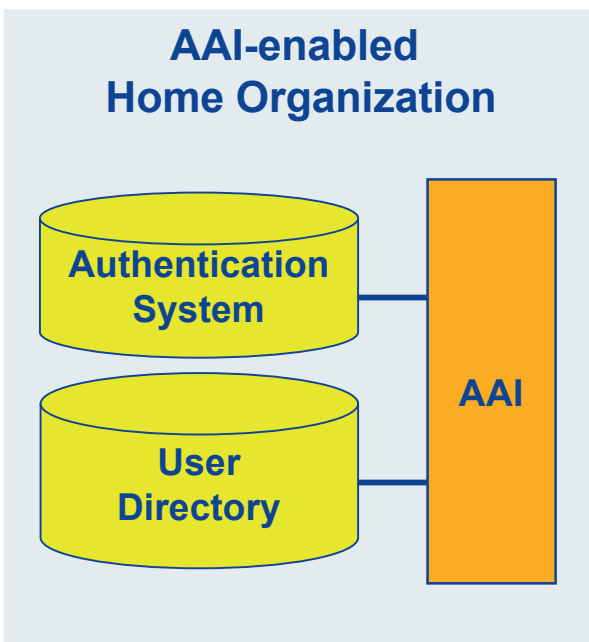

- **Authentication System**
 - any Apache compatible authentication method: LDAP, PAM, RADIUS, TACACS, end-user certificates, Web SSO (e.g. Pubcookie), ...
 - any Tomcat compatible authentication method: e.g. Web SSO (CAS)
- **Integration with User Directory via Java APIs**
 - LDAP via JNDI
 - Databases via JDBC

→ Login name is the link between the two parts

SSO = Single Sign On

- **AAI transfers user attributes from a Home Organization to a Resource**
 - **Requires a common understanding of what a value means**
 - ➔ **Authorization Attribute Specification v1.1**
http://www.switch.ch/aai/docs/AAI_Attr_Specs.pdf
- **A task force selected the attributes for SWITCHaai**
 - **minimal set to start with**
 - **attributes with pre-existing ‘common understanding’**
 - **in line with foreign activities**
- **Descriptions are LDIF like, but use of LDAP not required**

Authorization Attributes (2)

Personal attributes

- **Unique Identifier**
- **Surname**
- **Given name**

- **E-mail**
- **Address(es)**
- **Phone number(s)**
- **Preferred language**
- **Date of birth**
- **Gender**

Group membership

- **Name of Home Organization**
- **Type of Home Organization**
- **Affiliation (student, staff, faculty, ...)**

- **Study branch**
- **Study level**
- **Staff category**
- **Group membership**
- **Organization Path**
- **Organizational Unit Path**

- based on eduPerson spec
- study branch, study level, staff category are based on SHIS/SIUS
- username and password are missing
⇒ only used locally!
- commonName is missing
no common understanding on how to use it
- Matrikelnummer is missing
for data protection reasons

- **Based on 'Schweizerisches Hochschulinformationssystem'**
http://www.statistik.admin.ch/stat_ch/ber15/dber15.htm
http://www.statistik.admin.ch/stat_ch/ber15/fber15.htm
- **Example for Universities of Applied Sciences**
 - studyBranch1 (17 codes)**
 - 40000 Landwirtschaft – Agriculture
 - studyBranch2 (64 codes)**
 - 40200 Pflanzenproduktion – Production végétale
 - studyBranch3 (110 codes)**
 - 40202 Obst-, Wein-, Gartenbau – Arboriculture fruitière/Horticulture
 - studyLevel**
 - 40202-15 Studierende in der Studienphase, die zum Bachelor führt
Etudiants réguliers se trouvant dans une phase d'études
qui les conduit au titre de Bachelor

- **Only very broad categories, also derived from SHIS/SIUS**
- **Categories defined**

Teaching/Research

101/201 Professors and Permanent Researchers

102/202 Oberer Mittelbau – Corps intermédiaire supérieure

103/203 Unterer Mittelbau – Corps intermédiaire inférieure

Administration/Support/Technical

301 Administrative Personnel

302 Administrative Personnel: Apprentices and Interns

303 Technical Personnel

304 Technical Personnel: Apprentices and Interns

305 Janitors, Building Managers

306 Social and Wellness Personnel

307 Library Personnel

308 Safety Personnel



SWITCH

The Swiss Education & Research Network

Granting Access

Ueli Kienholz, <kienholz@switch.ch>

Method 1: SWITCHaai Attributes

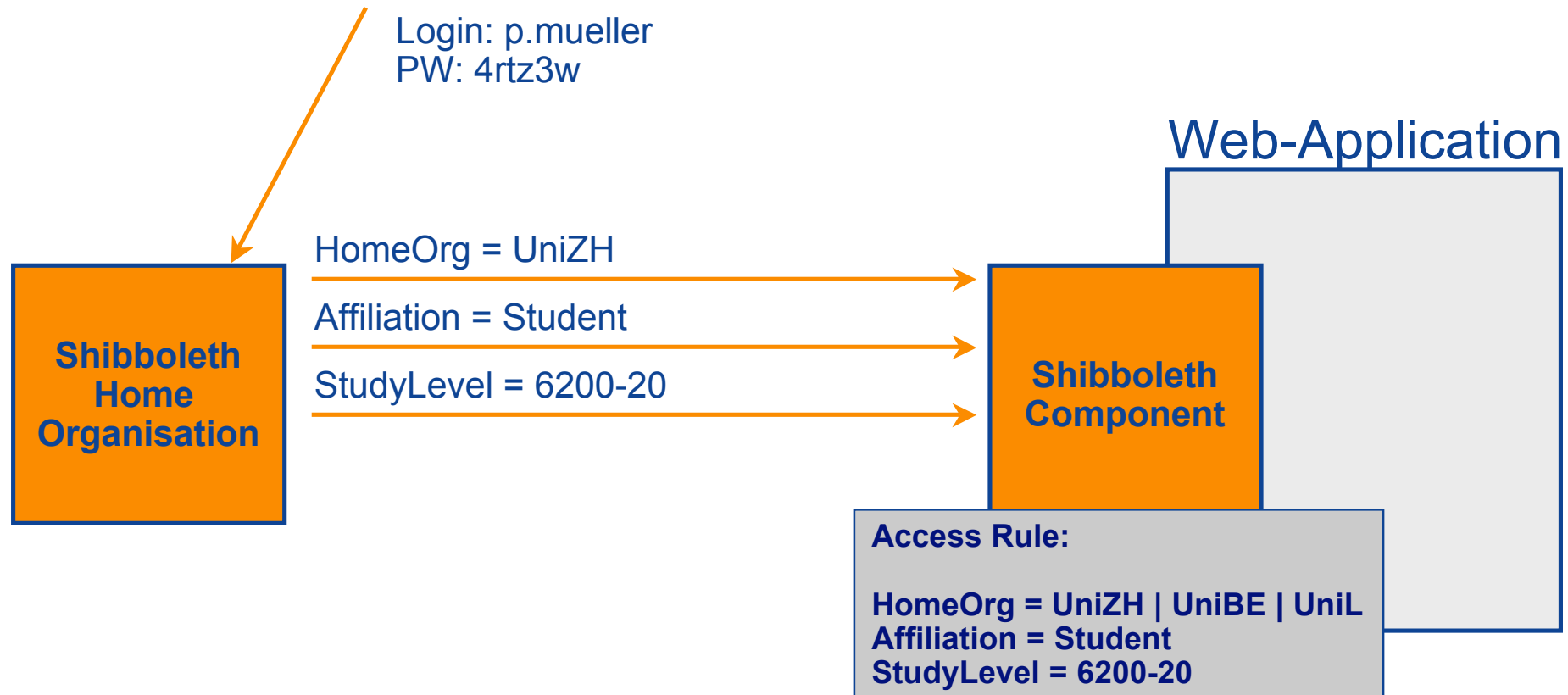

Method 2: Entitlement

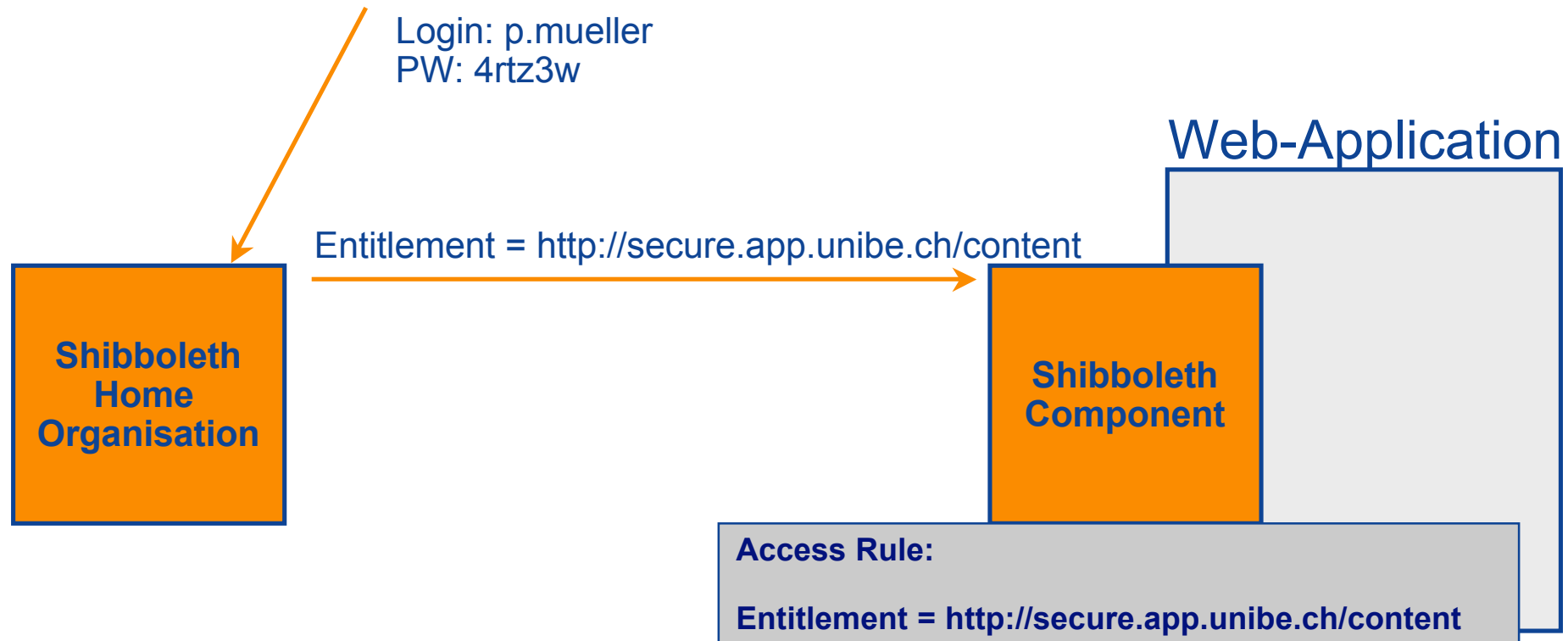

Method 3: Definition of additional Attributes

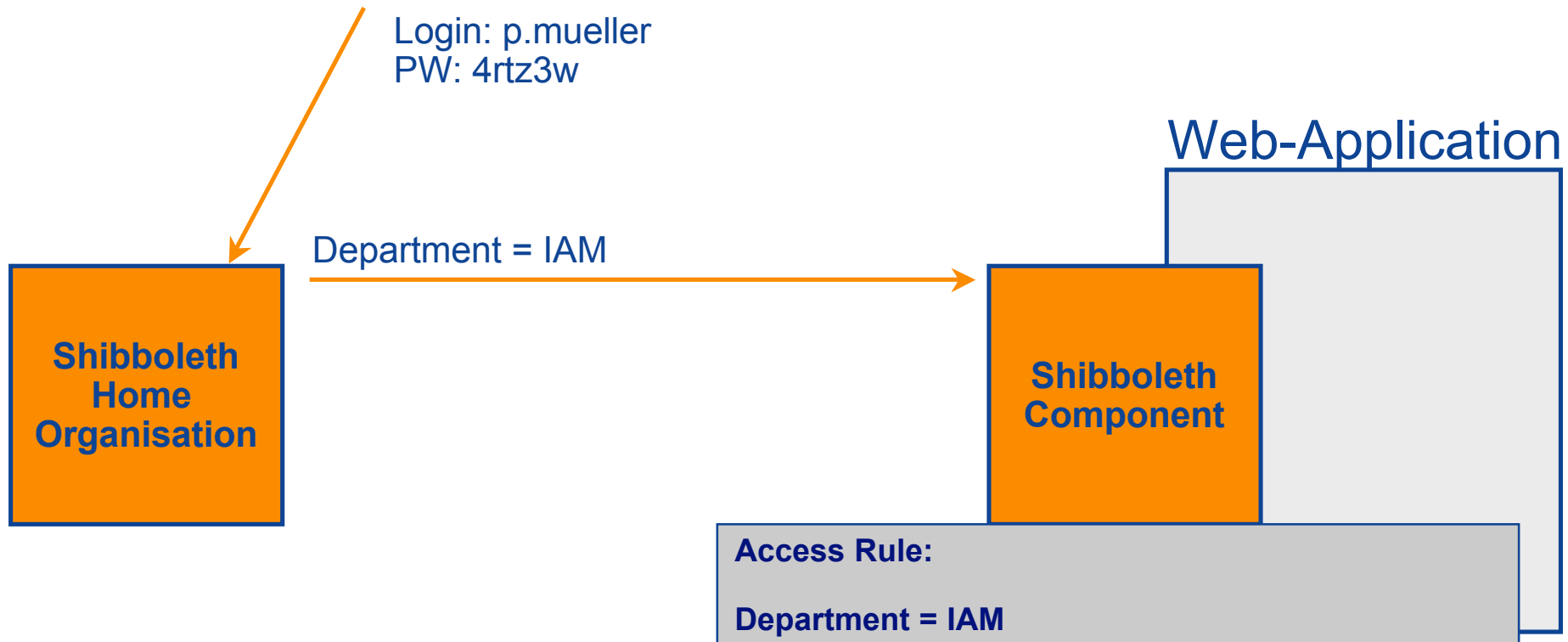

Method 4: Application has it's own Access Control

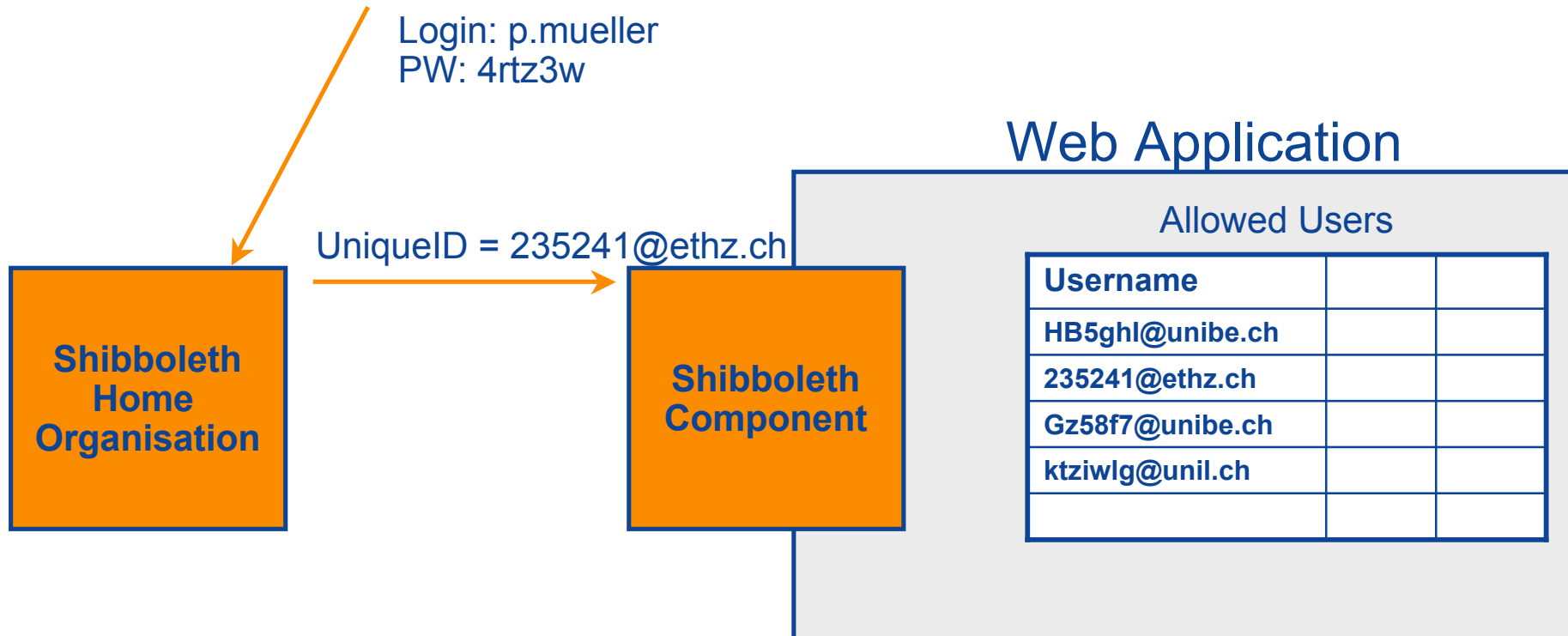



SWITCH

The Swiss Education & Research Network

System Requirements

Valéry Tschopp, <tschopp@switch.ch>

- Cookies
- Browser redirect
- SSL
- If no JavaScript: additional click necessary**

Supported Servers for Target Installations SWITCH

The Swiss Education & Research Network

Server OS

- Windows NT, 2000, XP, 2003
- Linux (any blend)
- Solaris

Web Servers

- Apache 1.3.x
- Apache 2.x
- IIS 4.x, 5.x, 6.x

Supported Applications

- ❑ **Static content on Apache or IIS**
- ❑ **Applications (PHP, Perl, ..) running on Apache**
- ❑ **JAVA-web-applications via mod_jk and Apache**
- ❑ **List of other „shibbolized“ applications at <http://shibboleth.internet2.edu/seas.html>**

- * ArtSTOR
- * Blackboard
- * CSA
- * Darwin Streaming Server
- * eAcademy
- * EBSCO Publishing
- * Elsevier ScienceDirect
- * ExLibris – SFX
- * EZProxy
- * Fedora
- * Gale
- * Higher Markets

- * JSTOR
- * Napster
- * NSDL
- * OCLC
- * Ovid Technologies Inc.
- * Proquest Information and Learning
- * SYMPA
- * TWiki
- * Web Assign
- * WebCT
- * Zope4Edu

Useful Information for a Target Deployment

- ❑ <http://www.switch.ch/aai/deployment.html>
- ❑ **With links to:**
 - ❑ **Shibboleth Target Deployment Guide (Internet2)**
 - ❑ **Compilation and Installation Guide (SWITCH)**
 - ❑ **SWITCHaai Configuration Guide (SWITCH)**
 - ❑ **SWITCHaai Sample Files (SWITCH)**

Requirement: SWITCHpki Server Certificates

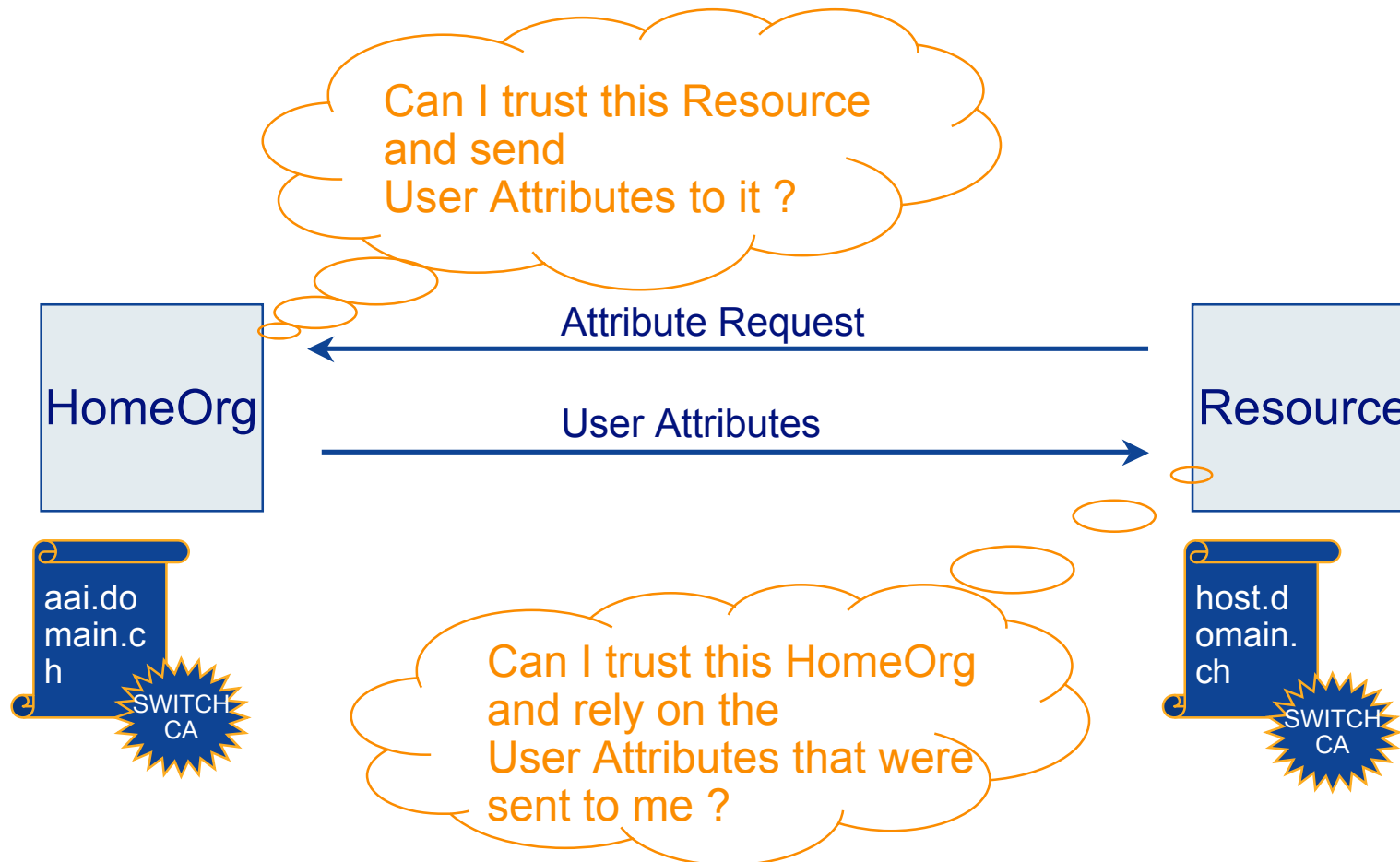

Exception 1: Mere Test-Purposes

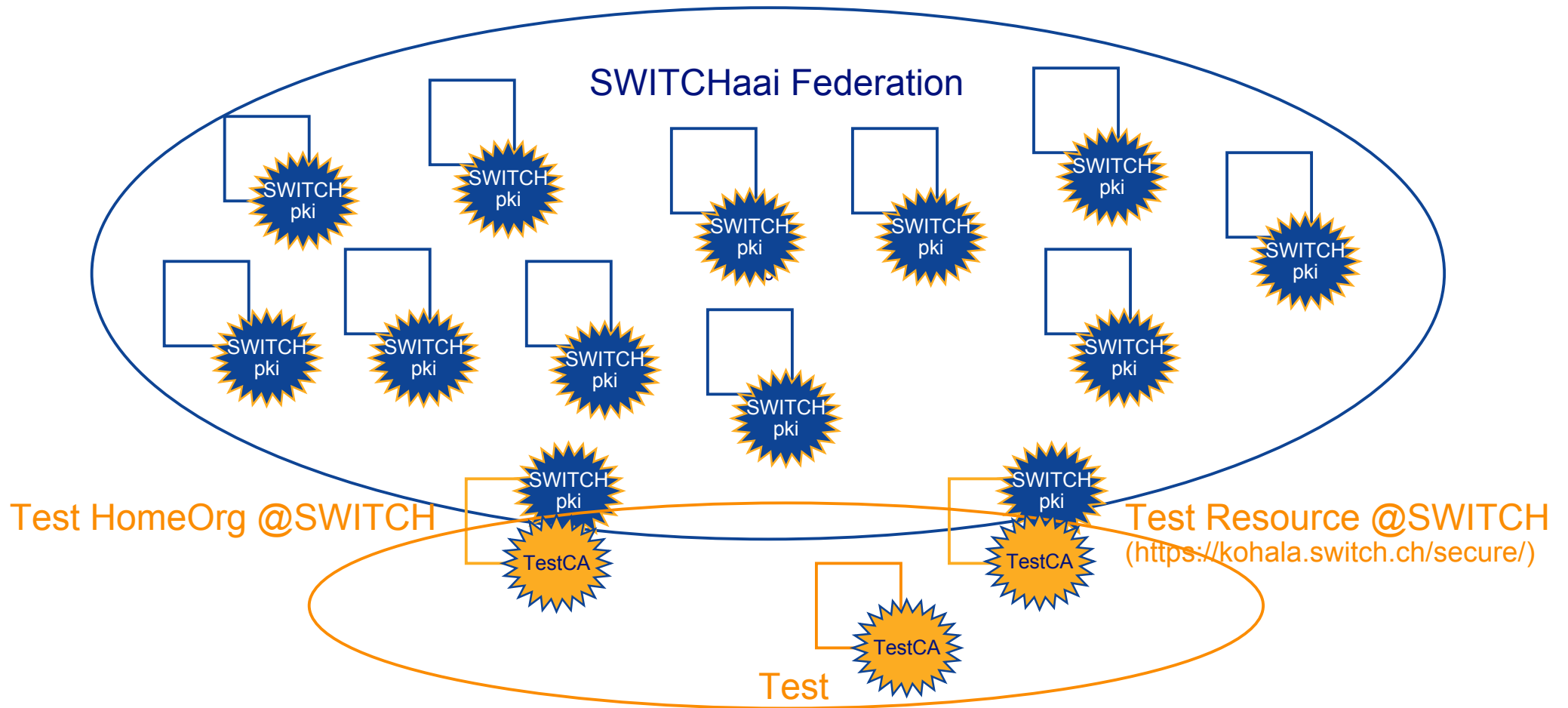

Exception 2: SSL connection from Browser

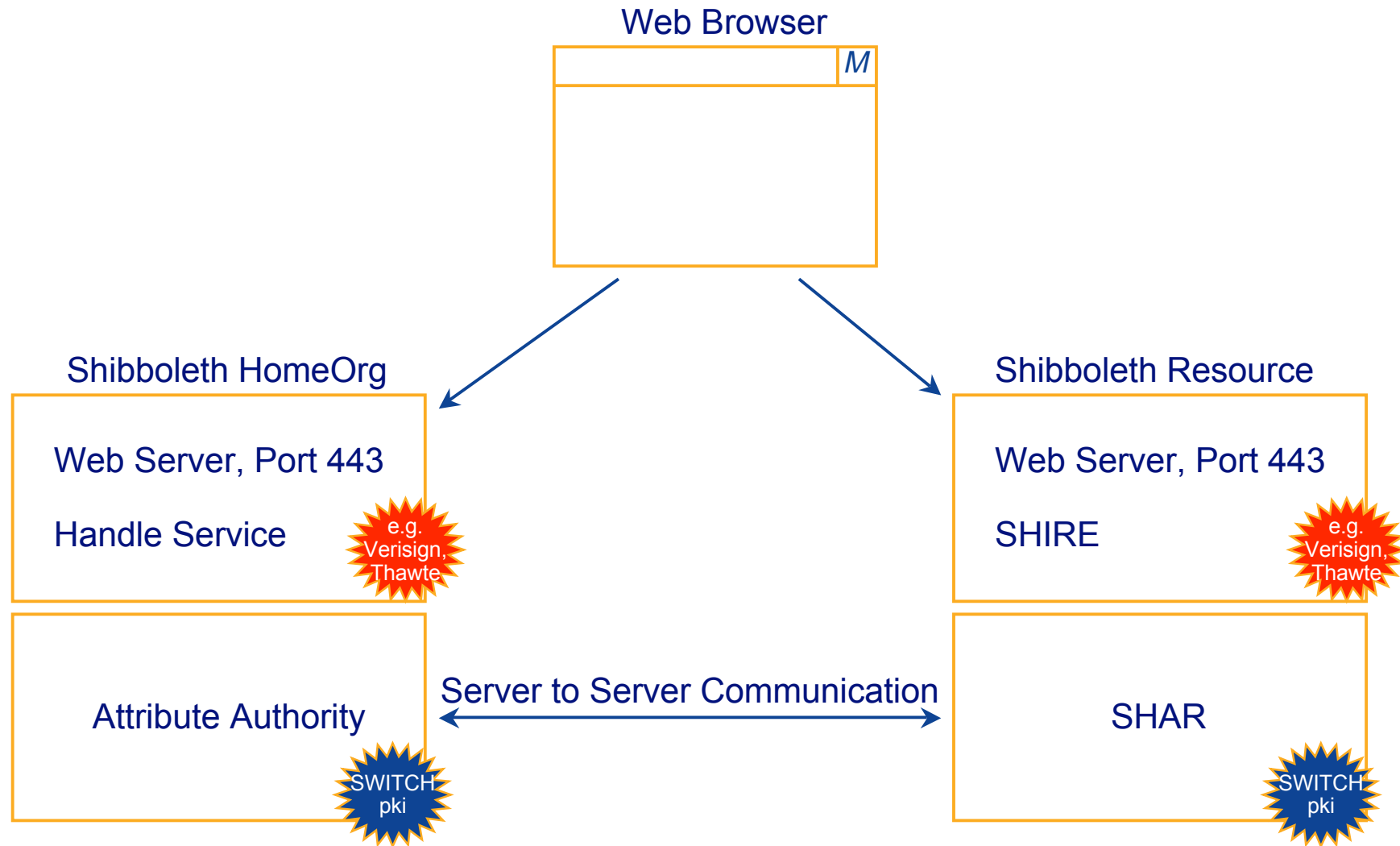

Q & A

<http://www.switch.ch/aai>

aai@switch.ch